

Interactions of the Lamento Motif and Jazz Harmonies in György Ligeti's *Arc-en-ciel*

Clifton Callender

Introduction

Example 1 reproduces the first five measures of *Arc-en-ciel*, the fifth of Ligeti's Etudes for Piano, which feature two notable characteristics of the composer's late style. The first is the lamento motif, a descending chromatic line that is the primary thematic material for numerous works.¹ In the opening of *Arc-en-ciel* this motif forms the basis for the melodic line in the uppermost voice. Typical of Ligeti is the interruption of the descending line ($B_5 \rightarrow A_5$, $C_6 \rightarrow B_5$, $D_6 \rightarrow A_5$ [second beat of m. 3], etc.) to return to a pitch at least as high as the beginning of the previous descending segment, the series of laments culminating in an extended descent from the highest point of a given musical passage. What is unique about this piece is that the lamento motif is used less consistently and thematically than in other works and does not appear to pervade the other voices of the texture. As we will see, a closer look reveals that the lamento motif is indeed quite pervasive in this etude.²

The second is the influence of jazz on Ligeti's late style. The composer openly acknowledges this influence, particularly that of Thelonius Monk and Bill Evans, and it is apparent in his harmonic language, which often draws upon chords associated with jazz, as well as frequent performance indications such as "like jazz" and "with swing." *Arc-en-ciel* is also unique in Ligeti's output in that jazz influences are particularly overt. Indeed, Ligeti has referred to this work as "almost a jazz piece."³ The harmonic vocabulary in the first five measures (see Example 2 for my own "lead sheet" version of mm. 1-5) is almost entirely drawn from major and minor seventh chords (indicated by $^7+$ and $^7-$, respectively), with two minor ninth chords ($^9-$), and a single minor-major seventh chord ($Bb^7\pm$). (The harmony labeled F^7- in parentheses is actually $F^{\flat 7}$. We will see below exactly how this half-diminished seventh chord comes about as a necessary alteration of the expected minor seventh chord.) While the chordal analysis in Example 2 is a useful starting point, it does

¹ For more on Ligeti's use of the lamento motif see Taylor 1994 and 2004. Among the many other of Ligeti's works to feature the lamento motif in a more overt manner are the Horn Trio (IV), Piano Etudes (VI), Piano Concerto (II and III), Violin Concerto (V), and Viola Sonata (IV and V).

² The use of descending chromatic figures in a musical lament expressing grief or mourning has a long and familiar tradition in Western music. Taylor (1994) uses the term lamento motif to refer to Ligeti's motivic use of descending chromatic fragments in the final movement of the Horn Trio and the second and third movements of the Piano Concerto. In each of these movements, and most of the other works in which this motif figures prominently, the context for these chromatic fragments is indeed a musical lament. (The final movement of the Horn Trio, the first work in which this motif occurs in Ligeti's music, is titled "Lamento.") While *Arc-en-ciel* is most definitely *not* a lament, I have opted to use the term "lamento motif" to make contact with Taylor's work and to connect *Arc-en-ciel* with the many other of Ligeti's works in which this motif plays an important role.

³ See Ligeti 1996.

Example 1. Arc-en-ciel, *mm.* 1-5.

Andante con eleganza, with swing, ♩ ca. 84

p dolce, con tenerezza, sempre legato, molto espressivo

con ped.

molto espr.

sub. p *poco cresc.*

Example 2. "Lead sheet" of *mm.* 1-5.

$C7+$ $C7-$ $Eb7+$ $Bb7+$ $Db7+$ $E7+$ $G7+$ $D7+$ $D7-$

$C7+$ $C7-$ $Bb7+$ $Bb9-$ $E7+$ $E7-$ $D7+$ $D9-$ $(F7-)$ $Eb7+$

$Gb7+$ $A7+$ $E7+$ $G7+$ $Bb7\pm$ $Db7+$

not tell us anything about the harmonic progressions. In particular, why does Ligeti choose these progressions and what makes them coherent? How do the simpler seventh chords in the opening five measures relate to the more dissonant remainder of the piece?⁴ As we will see, it is the interaction of the lamento motif and the harmonic vocabulary that determines these particular successions of chords.

⁴ Bouliane 1989 labels the chords of the first five measures in *Arc-en-ciel*, but does not pursue the questions of harmonic progression that will concern us here.

Arc-en-ciel poses more general problems for the analyst given its apparently free construction, which is in contrast to the rigorous exploration of specific musical techniques typical of many of the Etudes. In part this explains why relatively little has been written about the fifth Etude, especially in comparison with the first Etude, a phase-shifting isorhythmic *tour-de-force*, and the sixth, a polytempo fugue.⁵ While *Arc-en-ciel* is certainly freer on the surface than most of the Etudes, this freedom masks underlying constraints that guide Ligeti's compositional choices.⁶

Basic Transformations

We begin by looking at the initial harmonic progression, $C^{+7} \rightarrow C^{-7} \rightarrow E\flat^{+7}$. Viewing major and minor seventh chords as a combination of two perfect fifths separated by a major or minor third, the motion from C^{+7} to C^{-7} is achieved by *sliding* the upper fifth down by semitone, $\{E, B\} \rightarrow \{E\flat, B\flat\}$. These semitonal descents are clearly heard on the surface as $B_5, B_4, E_5,$ and E_4 progress to $B\flat_5, B\flat_4, E\flat_5,$ and $E\flat_4$, respectively. We can think of the subsequent motion from C^{-7} to $E\flat^{+7}$ as arising in a number of equivalent ways: 1) transposing the lower fifth up by a perfect fifth, $\{C, G\} \rightarrow \{G, D\}$, while holding the other fifth, $\{E\flat, B\flat\}$, in place; 2) *rotating* the lower fifth one step around the ascending circle-of-fifths; or 3) holding the pitch classes of the upper three voices, $\{E\flat, G, B\flat\}$, in common and moving the remaining pitch class as necessary to create a different major or minor seventh chord, $C \rightarrow D$. The opening progression thus manifests two different types of minimal alterations between chords—minimizing the size of the alterations from C^{+7} to C^{-7} through semitonal displacements and maximizing the number of common tones from C^{-7} to $E\flat^{+7}$ —resulting in the most efficient motions between major and minor seventh chords.⁷

Ligeti does not limit his harmonic language in this Etude to simple major and minor seventh chords, but draws upon a range of extended tertian harmonies as well as alterations of these chords. This is also typical of jazz practice, where composers freely move between various types of seventh, ninth, eleventh, and thirteenth chords. It is thus necessary to generalize the motions discussed above to a wider range of harmonic structures. The upper staff of Example 3 shows the combination of two stacked-fifths chords, again separated by a major or minor third, with the stacks distinguished by open and closed note heads. On the left, combining a pair of fifths in this way yields a major or minor seventh chord. On the right, combining indefinitely large stacks of fifths yields an alternating sequence of major and

⁵ For analyses of the first and sixth Etudes see Kinzler 1989 and Taylor 1997, respectively.

⁶ I would like to thank two anonymous readers and the staff at Integral for their helpful comments, as well as Michael Buchler for reading an earlier draft in my absence at the 2004 Joint Conference of the Society for Music Theory and American Musicological Society in Seattle.

⁷ On the psychological relevance of displacement size and number of moving voices for judgments of chordal distance see Krumhansl 1998 and Callender and Rogers 2006.

minor thirds, theoretically extending *ad infinitum*.⁸ If we take the first 3, 4, 5, 6, or 7 notes in this sequence, the results are the major and minor triads, seventh, ninth, eleventh, and thirteenth chords given on the bottom staff. (Note that C+ or C- stands for the entire family of chords generated in this manner. To indicate a specific member of the family we will use, e.g., C+⁹ or C-¹³.) The major quality chords on the left are drawn from a diatonic collection of one sharp, implying a Lydian quality that is typical of Ligeti's late style⁹, whereas the minor quality chords on the right imply a collection of two flats (Dorian). As the chords become larger, the distinction between major and minor quality diminishes, since, for example, C+¹³ implies the same diatonic collection as A-¹³.¹⁰

Example 3. *Combinations of stacked fifths.*

Example 4 generalizes the two motions between seventh chords discussed previously to these “tall” chords. The first takes the upper stack of fifths of C+ (not necessarily a triad!) and slides it down a semitone, yielding C-. This transformation will be called a *Slide* for obvious reasons, or *S/* for short. Applying a *Slide* to a minor chord moves the lower stack of

⁸ These tall chords arise from the transpositional combination of a (potentially infinite) sequence of stacked fifths and a major or minor third. A mathematician would write this as the “direct sum” of two sets: $\{p + 7i\}_{i=0}^{\infty} \oplus \{0, q\}, q \in \{3, 4\}$. For more on transpositional combination, see Cohn 1991.

⁹ In this piece the Lydian quality stems from the use of $\sharp 11$, which is typically used in jazz whenever the major third is also present in order to avoid the particularly dissonant minor ninth between this third and $\natural 11$. In other of Ligeti's late works, $\sharp 4$ arises through the use of synthetic scales (see the second movement of the Violin Concerto) and harmonic structures based on the overtone series (see the first movement of the Viola Sonata where the fourth scale degree is tuned according to the 11th partial of the overtone series and lies roughly halfway between $\flat 4$ and $\sharp 4$).

¹⁰ Depending on how the chord is voiced, increasing the size of the chord will also tend to blur the identity of the root. See the discussion of mm. 6-8 below. While seventh and ninth chords generated in the manner of Example 3 may belong to multiple diatonic collections, they still imply only a single diatonic collection in *Ar-en-ciel*. For instance, while $\{C, E, G, B\}$ belongs to both C and F Lydian collections (containing an $F\sharp$ or $F\flat$, respectively), C+⁷ in this Etudes implies only C Lydian. This is because the addition of Fs would be heard as a typical upper extension ($\sharp 11$) over the same root, while $F\flat$ ($\flat 11$) is a much less common extension, especially in conjunction with the major third. On the other hand, sufficiently large chords will not imply any diatonic collection. For example, C+¹⁵ contains both a $C\flat$ and a $C\sharp$.

fifths down a semitone, as in the motion from $C-$ to $C\flat+$.¹¹ The second transformation rotates the lower stack of fifths one step around the circle-of-fifths, as in $A-$ to $C+$ and $C+$ to $E-$. We will refer to this transformation as a *Rotation*, or *Rt* for short.

Example 4. *Slide and Rotation transformations.*

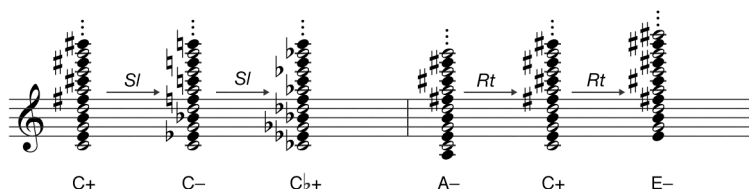

Example 5a is a *Tonnetz* of chords connected by *Slides* and *Rotations*. Motion down and to the right is equivalent to a *Slide*, while motion up and to the right is equivalent to a *Rotation*. These two transformations combine in the normal ways so that the motion from $C+$ to $E\flat+$ can be achieved by either a *Slide* followed by a *Rotation* ($SlRt$), $C+ \rightarrow C- \rightarrow E\flat+$, or a *Rotation* followed by a *Slide* ($RtSl$), $C+ \rightarrow E- \rightarrow E\flat+$. The motion from $E\flat+$ to $B\flat+$ is achieved by two *Rotations*, or Rt^2 , and so forth. (Motion in the opposite directions—up or down and to the left—is indicated by Sl^{-1} and Rt^{-1} , respectively.) Remember that the objects in this *Tonnetz* are not necessarily consonant triads—all sonorities generated in the manner of Example 3 are represented. The *Tonnetz* may be extended infinitely or wrapped into the familiar torus if octave equivalence is asserted. At times it will be useful to consider the collapsed *Tonnetz* of Example 5b in which chords implying the same diatonic collection, such as $C+$ and $A-$, are located at the same point. This point is labeled by the number of sharps in the collection. (Flat keys are considered enharmonically as sharp keys; e.g., $E\flat+$, which implies a Lydian collection with 2 flats, is the same as $D\sharp+$, which implies a Lydian collection with ten sharps.)¹²

¹¹ The *Sl* transformation described here is similar to but not the same as Lewin's (1987, 178) Slide (*S*) operation on consonant triads. Lewin defines his *S* as the operation "that preserves the third of a triad while changing its mode," which amounts to inverting a triad about its third. For example, applying *S* to C major yields $C\sharp$ minor, while applying *S* to $C\sharp$ minor yields C major. Thus, *S* is an involution, whereas *Sl* is not.

¹² For an historical overview of various *Tonnetz* and their contemporary use in neo-Riemannian theory see Cohn 1998. Weber (1821–1824) constructs a *Tonnetz* of major and minor chords/key regions (anticipated by Vial 1767) generated by the circle of fifths on one axis and a cycle of alternating parallel and relative keys on the other (e.g., $C \text{ c } E\flat \text{ e}\flat \dots$). Lerdahl (2001) arrives at Weber's space via a cognitive model of tonal pitch space. In terms of *Slides* and *Rotations*, Weber's space could be generated by Rt^2 on one axis and an alternation of *Sl* and *Rt* along the other. (These two motions are particularly important in *Arc-en-ciel*, as we will see below.) The collapsed space of Example 5b is equivalent to Weitzmann 1853, discussed in Cohn 2000, and Balzano 1980.

Example 5. (a) Tonnetz of stacked-fifths chords connected by Slide and Rotation. (b) Collapsed Tonnetz with chords that imply the same diatonic collection identified by the number of sharps in the collection (N.B.—F+ implies a diatonic collection of 0 sharps, C+ implies a diatonic collection of 1 sharp, and so forth).

a.					b.				
Ab+	B+	D+	F+	Ab+	9	6	3	0	9
A♭-	B-	D-	F-						
E+	G+	B♭+	C♯+	E+	5	2	11	8	5
E-	G-	B♭-	C♯-						
C+	E♭+	G♭+	A+	C+	1	10	7	4	1
C-	E♭-	G♭-	A-						
Ab+	B+	D+	F+	Ab+	9	6	3	0	9



Sl



Rt

As with the neo-Riemannian operations, *Slides* and *Rotations* can yield musically intriguing cycles.¹³ Example 6 shows the four possible cycles arising from the alternation of *Sl* and *Rt* and the two cycles resulting from iteration of either *Sl* or *Rt*. In each case, the cycle given is the one beginning with C+. Cycles beginning with a minor quality chord are the same as those given but with the order of transformations reversed. For example, the *RtSl* cycle containing C- is the same as the *S/Rt* cycle containing C+, and the *Sl¹Rt* cycle containing E- is the same as the *RtSl¹* containing C+. Changing the sign of the exponents for each transformation yields the cycle in reverse. Thus, the *Rt¹Sl¹* cycle beginning on C+ proceeds C+, A-, A+, ..., C+, while the *S/Rt¹* cycle beginning on C+ proceeds C+, A-, A♭+, and so on. Considering only the bottom three notes of each chord, each cycle in Example 6 has a counterpart arising from the neo-Riemannian operations Parallel (*P*), Relative (*R*), Leittonwechsel (*L*), and Slide (*S*).¹⁴ (Recall that the last operation, *S*, is *not* the same as the *Slide* considered here.) Let (X,Y) be the cycle X, Y, X, Y, Beginning with a major quality chord, (*Sl*,*Rt*) = (*P*,*R*), (*Rt*,*Sl*) = (*L*,*S*), (*Sl¹*,*Rt*) = (*S*,*R*), (*Rt*,*Sl¹*) = (*L*,*P*), (*Sl*,*Sl*) = (*P*,*S*), and (*Rt*,*Rt*) = (*L*,*R*). While the reader is encouraged to explore all of the cycles of tall chords, the *S/Rt* cycle is the one that is important for *Arv-en-ciel*, to which we now turn.¹⁵

¹³ See Cohn 1997 for a thorough investigation of cycles based on combinations of the neo-Riemannian operations *P*, *L*, and *R* and their analogues in various equal-tempered tuning systems.

¹⁴ In addition to the “standard” neo Riemannian operations of *P*, *L*, and *R*, the slide (*S*) is discussed in both Lewin 1987 and Cohn 1998. See footnote 11 for the definition of *S*.

¹⁵ The foregoing obviously draws on much recent and not-so-recent work in smooth voice-leading, especially in the context of neo-Riemannian theory. (See the 1998 special issue on neo-Riemannian theory of the *Journal of Music Theory* 42.2.) In particular, Strunk (2003) develops transformations on major and minor seventh and ninth chords that are analogous to the neo-Riemannian *P*, *R*, and *L* operations on consonant triads. (For example, C+^{7/9} goes to C-^{7/9} under *P*, to A-^{7/9} under *R*, and to E-^{7/9} under *L*.) The Slide and Rotation transformations discussed here are similar to but not the same as Strunk’s operations, which are involutions; e.g., C-^{7/9} goes back to C+^{7/9} under *P*. Lewin (1982) considers sequences (arranged horizontally) that are identical to those arranged vertically in Example 3

Example 6. *Cycles of alternating Slide and Rotation.*

The image shows six staves of musical notation, each representing a different cycle of Slide (Sl) and Rotation (Rt) operations. The notation consists of chords on a five-line staff, with various accidentals (sharps, flats, naturals) and dots above the notes. The cycles are labeled as follows:

- Staff 1: Sl Rt ...
- Staff 2: Rt Sl ...
- Staff 3: Rt Sl⁻¹ ...
- Staff 4: Sl⁻¹ Rt ...
- Staff 5: Sl Sl ...
- Staff 6: Rt Rt ...

 The notation is dense, with many notes and accidentals, indicating complex harmonic relationships between the chords in each cycle.

Analysis I of *Arc-en-ciel*

mm. 1-5

Example 7 reproduces the “lead sheet” of the first five measures. Motion between chords is analyzed in terms of *Slides* and *Rotations*. Alternate paths are given for progressions involving the two minor ninth chords, which may be analyzed in terms of their embedded seventh chords.¹⁶ It is clear by glancing at the Example that these motions are pervasive in the piece, at least for the first five measures. In Example 8 the harmonic progressions of measures 1-2 and 3-4 are plotted on the *Tonnetz* from before. (The two ninth chords, D⁻⁹ and B^{b-9}, are considered as [boxed] combinations of their embedded seventh chords.) While the particulars are somewhat different, the two paths are very similar. The variously shaded horizontal bands correspond to the three unique *Slide-Rotation* cycles. Portions of the paths that lie within a single band correspond to motion within a single cycle. Notice also

and defines a Shift operation that is equivalent to the *Rotation*. (In turn, Lewin’s sequence of alternating major and minor thirds is taken from Hauptmann 1853.) The relation between the *Sl* described here and Lewin’s (1987) SLIDE has already been discussed. (See footnote 11.)

¹⁶ In moving from B^{b-9} to E⁺⁷, one can imagine two equivalent paths: 1) B^{b-9} \xrightarrow{RtSlRt} E⁺⁹, at which point the ninth is omitted to yield E⁺⁷, or 2) apply a *SlRt* to the upper four notes of B^{b-9}, D^{b7} \xrightarrow{SlRt} E⁺⁷, while simultaneously dropping B^b. In a sense, since B^{b-9} is the combination of B^{b-7} and its rotation, D^{b-7}, the initial *Rotation* in the *RtSlRt* from B^{b-9} to E⁺⁷ is already contained within the first sonority.

that there is an orderly progression within and between bands, or cycles—the paths always move to the right within a given band or ascend to the next “highest” band. Two obvious questions come to mind: “Why are these motions so pervasive in *Arc-en-ciel*?” and “Why are these paths so similar?” Answering these two more specific questions amounts to answering the more general questions posed in the introduction.

Example 7. *Slides and Rotations in Ligeti, Arc-en-ciel, mm. 1-5.*

Example 7 shows three staves of musical notation in 3/4 time. The first staff contains measures 1-2 with chords C7+, E7+, Bb7+, Bb7+, Db7+, E7+, G7+, D7+, and Db7+. The second staff contains measures 3-4 with chords C7+, Bb7+, Bb9, E7+, E7+, D7+, D9, (F7-), and Eb7+. The third staff contains measures 5-6 with chords Gb7+, A7+, E7+, G7+, Bb7+, and Db7+. Movement labels include Sl, Rts, SIRT, Rl, Rl2, Rl3, Rl4, Rl5, Rl6, Rl7, Rl8, Rl9, Rl10, Rl11, Rl12, Rl13, Rl14, Rl15, Rl16, Rl17, Rl18, Rl19, Rl20, Rl21, Rl22, Rl23, Rl24, Rl25, Rl26, Rl27, Rl28, Rl29, Rl30, Rl31, Rl32, Rl33, Rl34, Rl35, Rl36, Rl37, Rl38, Rl39, Rl40, Rl41, Rl42, Rl43, Rl44, Rl45, Rl46, Rl47, Rl48, Rl49, Rl50, Rl51, Rl52, Rl53, Rl54, Rl55, Rl56, Rl57, Rl58, Rl59, Rl60, Rl61, Rl62, Rl63, Rl64, Rl65, Rl66, Rl67, Rl68, Rl69, Rl70, Rl71, Rl72, Rl73, Rl74, Rl75, Rl76, Rl77, Rl78, Rl79, Rl80, Rl81, Rl82, Rl83, Rl84, Rl85, Rl86, Rl87, Rl88, Rl89, Rl90, Rl91, Rl92, Rl93, Rl94, Rl95, Rl96, Rl97, Rl98, Rl99, Rl100.

Example 8. *Arc-en-ciel, mm. 1-2 and mm. 3-4.*

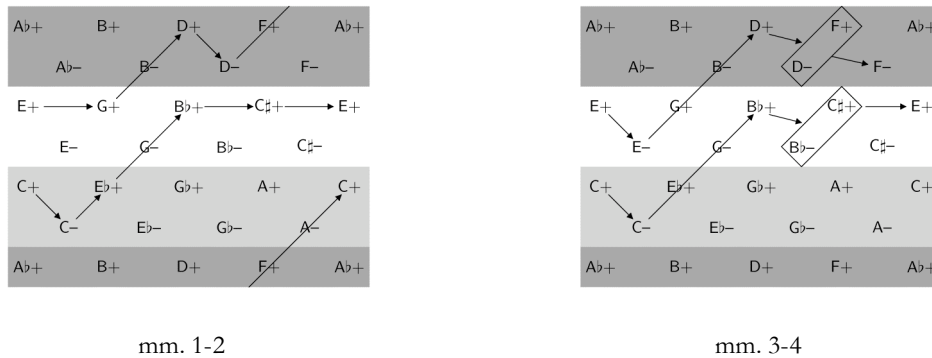

The answers lie in the interaction of the lamento motif and major and minor seventh chords (particularly major seventh chords, since these are much more common in the Etude). Turning to Example 9, if we slide the upper fifth of Af+7 from {C,G} to {B,Fs#}, there are two major seventh chords that contain the latter fifth—B+7 and G+7. Alternatively, if we slide the lower fifth from {Ab, Eb} to {G,D}, the latter is contained in Eb+7 and G+7. Since Ligeti never slides an entire chord down by half step, this leaves only two motions: T₃, a *Slide-Rotation*, or T₇, a *double-Rotation*.¹⁷ Note that a *Slide-Rotation* moves

¹⁷ This staggered semitonal descent is an example of Ligeti’s more general preference for gradual change in his mature works. A good example is the harmonic progression of six-note chords from the

the upper fifth down by half step to become the lower fifth, while a *double-Rotation* moves the lower fifth down by half step to become the upper fifth. Thus, an alternation of *Slide-Rotation* and *double-Rotation* will yield a chain of parallel perfect fifths descending by semitone.

Example 9. *Connecting major seventh chords via the lamento motif.*



On the left side of Example 10 is this just-described alternation of *SIRt* and R^2 and the resulting chain of descending parallel fifths. (Slurs in this and following examples highlight descending chromatic lines.) Note that every other chord in this alternation descends by whole step, yielding a T_{10} -cycle. Repeated *Slide-Rotations* have the opposite effect, shown on the right side of Example 10. Each repetition breaks the previous descent and initiates a new one. (Note that there is another descending line embedded within this cycle, beginning with the upper note of the upper fifth, $F\sharp$ to F , and continuing with the lower note of the upper fifth, F to E .)

Example 10. *Lamento lines and chains via SIRt and R^2 .*

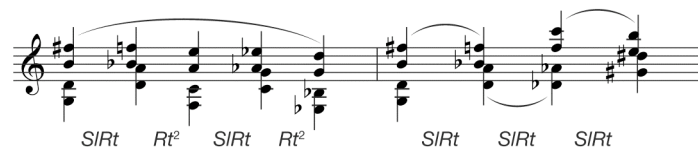

Example 11 gathers the three unique *Slide-Rotation* cycles into three circular paths. The three circles are labeled 0, 1, and 2, respectively. Recall that $C+$ implies a collection with one sharp. Similarly, $A+$ implies four sharps, $G\flat+$ or $F\sharp+$ implies seven sharps, and $E\flat+$ or $D\sharp+$ implies 10 sharps. The number of sharps implied by these four chords (1, 4, 7, and 10) are all congruent to 1 mod. 3, which is why this cycle is labeled cycle 1. Similarly, the implied collections in the left cycle contain 0 mod. 3 sharps, and those in the bottom cycle contain 2 mod. 3 sharps.¹⁸ Since the semitonal motion is always descending (they are laments, after

first of his 1976 *Three Pieces for Two Pianos (Monument)* in which a single pitch class at a time is lowered by a semitone: $\{F, G\flat, A, B, C, D\flat\} \rightarrow \{E, G\flat, A, B, C, D\flat\} \rightarrow \{E, G\flat, A, B\flat, C, D\flat\} \rightarrow \{E, G\flat, A, B\flat, C\flat, D\flat\} \rightarrow \{E\flat, G\flat, A, B\flat, C\flat, D\flat\} \rightarrow \{E\flat, G\flat, A\flat, B\flat, C\flat, D\flat\}$ and so on. For more on the melodic and harmonic techniques in Ligeti's music of the 1960s and 70s see Bernard 1994, Clendinning 1993, Morrison 1985, and Roig-Francolí 1995.

¹⁸ The spatial arrangement of chords (understood as major and minor triads) in Example 11 is essentially identical to Lerdahl's (2001) triadic/octatonic chordal/regional space. See also Cohn's

all), motion within each cycle always travels in one direction, clockwise as they are laid out on the page. Motion between cycles, again always in a clockwise direction, is achieved by a *double-Rotation*. This imparts a specific order on inter-cycle motion, moving from cycle 0 to cycle 1 to cycle 2 and continuing. On the *Tonnetz* in Example 8, these intra- and inter-cycle orderings are manifest in paths always moving to the right within a given band, and always ascending when moving from one band to the next.

Example 11. *SlRt cycles linked by Rt^2 .*

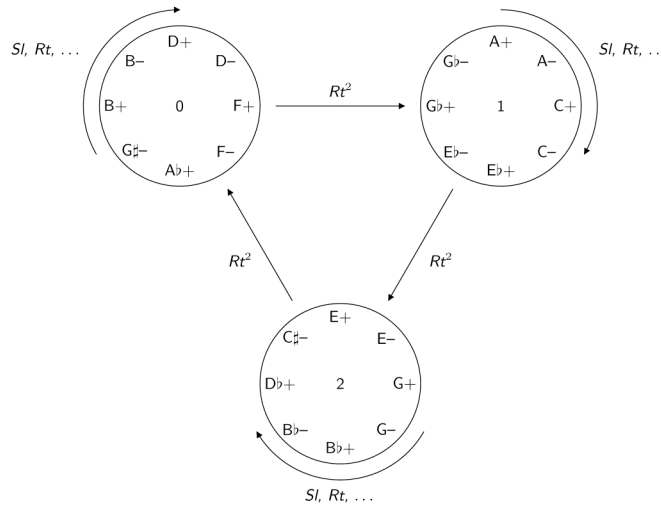

Example 12 demonstrates the three ways in which T_{10} occurs throughout the piece. The path on the left consists of a *Slide-Rotation* followed by a *double-Rotation*. Splitting the *Slide-Rotation* into its component transformations yields the path in the middle, which is the opening progression. Combining the single *Rotation* with the *double-Rotation* yields the path on the right, which is the progression beginning in m. 3. These three slightly different paths explain most of the subtle differences in the paths of Example 8.

Example 12. *Alternate paths connecting T_{10} -related chords.*

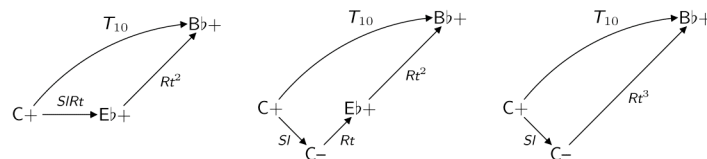

(1996) hyperhexatonic system, which is an analogous arrangement of the 24 consonant triads into four disjoint *LP* cycles.

Example 13 highlights the interaction of these cycles and the lamento motif. The top line is the uppermost voice of the opening five measures with slurs grouping distinct laments. (This line is transposed down one octave for convenience. Slurs in the figure do not correspond to phrase slurs in the original score.) In the bass, the given pitches are the roots of the corresponding harmonies, with open and closed note heads indicating major and minor qualities, respectively. (As before, the ninth chords are indicated as combinations of their component seventh chords; e.g., Bb^{-9} is indicated by a closed note head on Bb and an open notehead on $D\flat$.) Stemmed notes and slurs indicate T_{10} -cycles, while brackets above the bass line indicate *Slide-Rotation* cycles. The correlation between longer laments in the top staff and T_{10} -cycles in the bottom staff is evident as is the interruption of these laments by extended *Slide-Rotation* cycles. Only at the end does this correlation not hold. The next to last chord is a Bb minor-major seventh chord, containing elements of both Bb major and Bb minor seventh chords (and thus indicated by both open and closed note heads on Bb). Both of these chords belong to the same *Slide-Rotation* cycle, but the inclusion of $D\flat$ in the chord, where $D\sharp$ is expected, allows the Lamento line to continue its semitonal descent. This subtle alteration also prepares for the more substantial alterations and resulting dissonant harmonies to come.

Example 13. *Interaction of S/Rt cycles, T_{10} cycles, and the lamento motif.*



A similar alteration occurs with the $F^{\circ 7}$ chord in m. 4 that we have been labeling (F^-) . Example 14 gives two alternate versions of this chord. In (a) $F^{\circ 7}$ has been replaced by F^{-9} which preserves most of the original chord. However, it has the obvious problem that the soprano does not descend by half step, interrupting the extended chromatic descent from $D\sharp_6$ in m. 3 to F_5 in m. 5 (this line switching from the soprano to the “alto” immediately after the *sub. p.*). In (b) the substituted C^{+7} allows this chromatic descent to continue, but is unsatisfactory for harmonic reasons. D^{-9} followed by C^{+7} would yield a passage conforming to a single diatonic collection for a full seven sixteenth-notes, which is much longer than the general harmonic rhythm of the Etude. Thus, version (a) is melodically static while version (b) is harmonically static. Ligeti’s solution takes the best features of both— $F^{\circ 7}$ combines the harmonic motion of F^{-9} while continuing the chromatic descent by altering C to B.

In addition to the multiple semitonal descents discussed in connection with Example 10, it is also possible to create semitonal motion within a single major seventh chord, moving from the root to the seventh of the chord. The combination of all of these descents makes the lamento motif much more pervasive than just the top melodic line. Example 15 draws

Example 14. *Alternate versions of m. 4 with F^{∅7} replaced by (a) F⁻⁹ and (b) C⁺⁷.*

Example 14(a) shows a piano accompaniment for a four-measure phrase. The melody is in the right hand, and the bass line is in the left hand. The chords are labeled as D+, D-, C+, and Eb+.

(a)

Example 14(b) shows the same piano accompaniment as in (a), but with different chord voicings. The chords are labeled as D+7, D-, F⁻⁹, and Eb7+.

(b)

Example 15. *Multiple laments in Arc-en-ciel, mm. 1-5.*

Example 15 shows a piano accompaniment for five measures. The melody is in the right hand, and the bass line is in the left hand. The notation features multiple laments, which are descents in the melody, highlighted on the surface and slightly obscured through octave displacements.

out these laments that are embedded within the musical texture. Portions of these descents are highlighted on the surface, while others are slightly obscured through octave displacements. (For convenience, descents obscured by octave displacement are placed in the same octave in the Example.) Nonetheless, all of these lines are clearly audible and are driving the harmonic progression. The implicit simultaneous presentation of multiple

lamento lines in the fifth Etude foreshadows the explicit use of the lamento motif in multiple voices in the polytempo fugue of the sixth Etude, *Automne à Varsovie*.¹⁹

There is a strong similarity between the technique used in the opening of *Arc-en-ciel* and the common chromatic technique in Chopin that features implicit pitch-class laments in exact sequences.²⁰ Example 16 demonstrates the basis of this technique with a diminished seventh chord transposed by descending semitone and ascending major second, perfect fourth, and minor sixth. While all four transpositions are distinct in pitch space, they are the same pattern of parallel laments in pitch-class space.²¹

Example 16. *Pitch space transpositions of the diminished-seventh chord giving rise to semitonal descents in pitch-class space.*

The image shows two staves of musical notation. The top staff is labeled 'pitch space' and the bottom staff is labeled 'pc space'. Both staves are in 2/4 time and show a sequence of four diminished-seventh chords. The pitch space staff shows the chords as distinct vertical groupings of notes, while the pc space staff shows the same chords as a single horizontal line of notes, illustrating the concept of pitch-class space.

These sequences are typically embellished by staggering the laments, yielding dominant, half-diminished, and minor seventh chords and French augmented sixths. Example 17 shows two examples (given as harmonic reductions) of these embellishments in sequence. In (a), the laments are clearly presented on the surface through a sequence by descending semitone.²² In (b), while the legs are sequenced by ascending whole-tones, the laments are still clearly audible. For example, Af_4 in the soprano switches to the alto voice in the second half of m. 29, descends to G_4 in the tenor in m. 30, and is displaced an octave lower to G_3 in the bass in m. 31. Similarly, Eb_4 in the tenor is transferred to Eb_3 in the bass and descends to D_4 , after which this pitch class lament continues with Db_5 and C_5 in the soprano. This combination of semitonal descents with a rotation of voices such that the soprano continues to initiate chromatic descents at ever higher pitches is very similar to what we observed in the opening five measures of *Arc-en-ciel*.

mm. 16-17 and 19-20

Even in passages where the lamento motif does not appear to be present, motions similar to those in mm. 1-5 govern the harmonic progression. For example, consider mm.

¹⁹ See Taylor 1994 and 1997.

²⁰ Ligeti acknowledged Chopin's influence on his own piano writing both in liner notes for the Etudes (1993) and the title of the second of his Three Pieces for Two Pianos: *Self-portrait with Reich and Riley (and Chopin is there, too)*.

²¹ This is due to the symmetrical structure of the diminished seventh chord in pitch-class space, where all transpositions are congruent (mod 3) to T_0 , T_1 , or T_2 .

²² For a transformational approach to the voice leading in this excerpt see Childs 1998.

Example 17. *Pitch-class laments in Chopin's (a) Prelude in C \sharp minor, cadenza, and (b) Etude in E \flat minor, mm. 29-31.*

(a)

(b)

Example 18. *Ligeti, Arc-en-ciel, mm. 16-17.*

meno mosso *sub. p* *cresc.* *mf* *poco a poco cresc.* *poco rall.* *a tempo*

16

C \sharp + G+ D+ F+ C+ E \flat + B \flat + B \flat - E+ E- (D+)

16-17, given in Example 18. The left hand has a series of major and minor seventh chords, while the right hand has dissonant material that gradually comes into agreement with the harmonies of the left. The left-hand progression is plotted on the collapsed *Tonnetz* in Example 19. (Since major and minor quality chords implying the same diatonic collection are located at the same point in the collapsed *Tonnetz*, C \sharp - and B \flat - are located at the same point as E+ and D \flat +, respectively. These points are labeled C \sharp -/E+ and B \flat -/D \flat +) The progression begins with C \sharp -/E+ and progresses in a staircase-fashion to B \flat -/D \flat +. A horizontal shift to the right corresponds to a subtraction of three sharps from the implied diatonic collection while motion up and to the right corresponds to an addition of one sharp. We can see that the progression contains a pair of T_{10} cycles, indicated in Example 19

by slurs. The resulting descending perfect fifths are given at the bottom of Example 19. While those descents mostly are not highlighted on the surface, they are nonetheless driving the harmonic progression.

Example 19. T_{10} cycles and implicit laments in mm. 16-17

The image shows a musical staff with a treble clef and a key signature of two sharps (F# and C#). The staff contains a series of chords. Above the staff, a graph shows the harmonic progression with labels: C#-/E+, G+, D+, F+, C+, Eb+, Bb+, Bb-/Db+, E+, E-/G+, and (D+). The graph consists of two curved lines that connect the labels, illustrating the T10 cycles and implicit laments.

A similar passage occurs in measure 19, shown in Example 20, where the left hand again plays a series of major and minor seventh chords, this time against a mostly dissonant pedal (*quasi una campana*). The top portion of Example 21 is a graph of this harmonic progression highlighting the *Slide-Rotation* cycles. On the bottom of the example are the laments contained in these cycles. Unlike the previous example, these laments are not obscured through octave displacements, though none is highlighted as a primary melodic line.

Example 20. Ligeti, *Arc-en-ciel*, mm. 19-20.

The image shows a musical score for two staves. The top staff is in treble clef with a key signature of two sharps (F# and C#). It contains a series of chords and a melodic line. The bottom staff is in bass clef with a key signature of two sharps (F# and C#). It contains a series of chords and a melodic line. Above the top staff, a graph shows the harmonic progression with labels: C#-, G+, G-, Db+, Ab+, G#-, D+, A+, C+, Eb+, and Gb±7(M7). The graph consists of two curved lines that connect the labels, illustrating the Slide-Rotation cycles and laments.

(poco rall.) - - - - - a tempo, con tenerezza

quasi una campana sim. sim.

19 pp dolciss. molto espr.

C#- G+ G- Db+ Ab+ G#- D+ A+ C+ Eb+ Gb±7(M7)

The portion of the graph around the top right cycle begins at the *a tempo* in measure 20 with a minor third cycle beginning on A+ and continuing through Gb+ midway through the measure. The actual harmony is not quite a major seventh chord. It contains both a split third (major and minor third above the root sounding simultaneously) and a split seventh.

The combination of root, major seventh, and minor seventh (e.g., $C7^{(ma7)}$) is noted by James Kurzdorfer as a characteristic cluster in the music of Thelonius Monk.²³ We will refer to such sonorities as “Monk sevenths.” These sonorities maintain the function of major seventh chords despite the additional “spice” provided by the minor seventh.

Example 21. T_3 cycles and implicit laments in mm. 19-20.

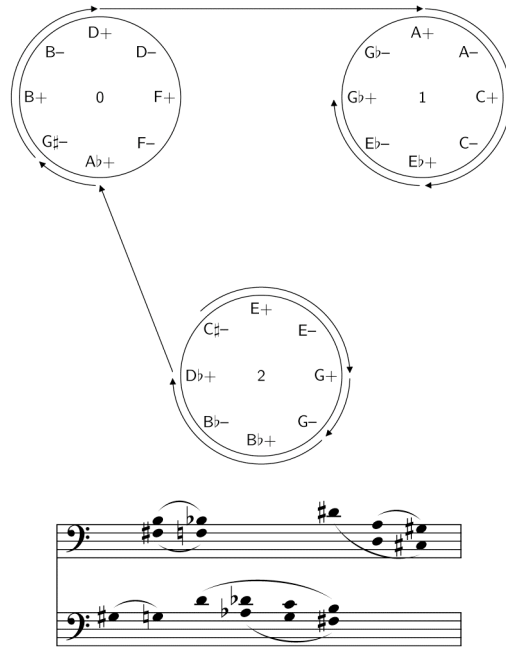

Analysis II of *Arc-en-ciel*

The first analysis section focused on those passages in which the harmonies consist primarily of major and minor seventh chords. As mentioned earlier, the etude also draws upon a range of extended tertian harmonies as well as alterations of these chords. In this second analysis section, we turn our attention to two passages marked by these more complex harmonies.

mm. 6-8

Continuing from the opening five bars discussed above, Example 22 reproduces mm. 6-8. The harmonic language is more complicated in this passage in part due to the frequent use of ninths, elevenths, and thirteenths. These chordal extensions raise a number of issues. First, the distinction between major and minor quality chords begins to blur. For example, while the beginning of m. 6 is clearly $A\flat^{-7}$, the addition of F and $B\flat$ suggest $A\flat^{-13}$, which

²³ See Kurzdorfer 1996.

contains the same pitch-classes as B^{+13} . Should we hear $A\flat-$ persisting through the first dotted-quarter of the measure, or is there a change to B^+ with the fifth and sixth sixteenth notes? Because this latter chord is not voiced in a way that emphasizes one or the other possible “roots,” the question is, in some sense, ill-formed. Without a clearly projected root, both $A\flat^{-13}$ and B^{+13} are simply the diatonic collection with six flats or six sharps (B Lydian). Similarly, while the harmony for the seventh and eighth sixteenths is clearly B^{-9} , does the chord for the ninth and tenth sixteenths constitute a change of harmony, D^{+11} with an atypical voicing, or an extension of $B-$ to include the eleventh and thirteenth? I tend to hear the former, but both interpretations are consistent with the more general point that these four sixteenths lie within a single diatonic collection, D Lydian. For the remainder of the paper, if there is ambiguity between major or minor quality for a chord, I will either indicate both possibilities (e.g., $A\flat-/B^+$), the major quality only, or the integer corresponding to the collapsed *Tonnetz* of Example 5 (the number of sharps in the implied diatonic collection).

Example 22. *Ligeti, Are-en-ciel, mm. 6-8.*

The image displays a musical score for Example 22, Ligeti's "Are-en-ciel" (mm. 6-8). It consists of two systems of music. The top system features two staves of music. The first staff has dynamics: -sub. p, cresc., and mf. The second staff has dynamics: p, poco cresc., and mf. The bottom system shows a grand staff with dynamics: p, poco cresc., and mf. Chord symbols are provided below the staves: $A\flat-/B^+$, $B-/D^+$, and $A^7\#9 C^+$.

A second issue to arise with the inclusion of upper chord tones is that the possibilities for semitonal motion increase dramatically. For example, while there are no possibilities for semitonal descents in the motion from C^{+7} to $D\flat^{+7}$, there are five such descents available when moving from C^{+13} to $D\flat^{+13}$: $D \rightarrow D\flat$, $E \rightarrow E\flat$, $F\sharp \rightarrow F$, $A \rightarrow A\flat$, and $B \rightarrow B\flat$. Thus, the constraints on harmonic progression arising from the combination of the lament motif and major and minor seventh chords no longer apply. Nevertheless, Ligeti continues to employ the same limited number of harmonic motions, which can be seen by plotting the

harmonic progression of mm. 6-7 on the collapsed *Tonnetz*, shown in Example 23. As before, motions within a given band correspond to portions of a *S/Rt* cycle and chains of T_{10} cycles are connected by slurs.

Example 23. *Measures 6-8 on the collapsed Tonnetz.*

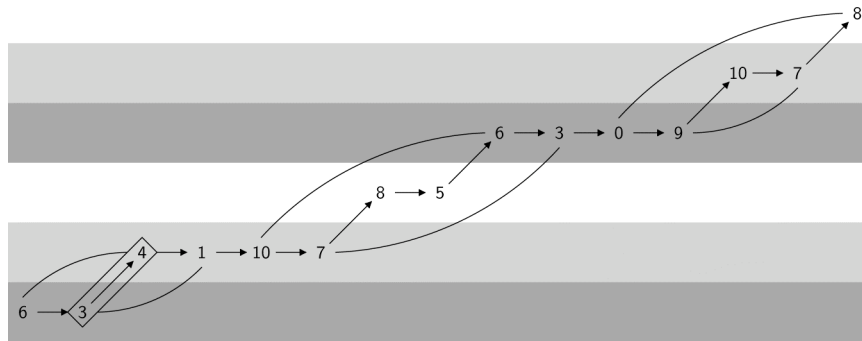

Example 24. *Simplified version of mm. 6-7.*

There are a few complications in moving from the musical surface to the harmonic reduction of Example 23. First, consider the chord labeled A^{7s9} in m. 6, using the standard jazz chord symbol for this altered dominant. This chord serves as a link between the climactic point of the first phrase, D^{+11} , and the end of the phrase, $C^{+7} \rightarrow E\flat^7$. (D^{+11} is the climactic point in terms of the soprano, dynamics, and harmonic tension, due to the extensions and, in particular, the voicing of A above $G\sharp$ s resulting in an especially dissonant minor ninth.) Since A^{+7} is already included in D^{+11} (and represented in Example 23 by the box enclosing both 3, for D^+ , and 4, for A^+), the most natural connection between D^{+11} and C^{+7} is via A^- : $D^+/A^+ \rightarrow A^- \rightarrow C^+$. Example 24 gives an alternative of the end of m. 6 that incorporates this progression and sounds quite natural. However, simply substituting A^{-7} for $A^{7\sharp 9}$ in the actual music is unsatisfactory, because the decrease in harmonic tension from D^{+11} to A^{-7} is too drastic; the harmonic tension is simply ended rather than resolved. (The lessening of harmonic tension in Example 24 by restricting the vocabulary to seventh chords is the reason A^{-7} sounds satisfactory in the simplified version.) Ligeti's solution, transforming a minor seventh into an altered dominant through the addition of a single pitch

class, $D\flat$, resolves the tension both harmonically— $A7^{\sharp 9}$ is less dissonant than $D+^{11}$ in this voicing but more dissonant than $C+^7$ —and linearly by way of the descending parallel major sevenths: $\{D_5, C\sharp_6\} \rightarrow \{D\flat_5, C_6\} \rightarrow \{C_5, B_6\}$.

The harmonic progression beginning with the descending eighth-note triplets in m. 7 is fairly clear and even somewhat predictable relative to the preceding music, but there are three moments to consider briefly, the first two identified in Example 22 by parentheses. The $B\flat$ major triad in m. 7 is easily heard as a passing chord between B major (as part of B+) and A major (as part of D+). Similarly, the pitch content for the first quarter-note of m. 8 supports F+ with the exception of $E\flat_6$, which also functions as a passing tone between E_6 and D_6 , and $B\flat_6$. Finally, the arrival of the alto line on B_5 on the third quarter of m. 8 (as part of the $D\flat$ dominant seventh chord, $D\flat^7$) avoids the expected arrival on $D\flat+$, which would continue the T_{10} -cycle $F+ \rightarrow E\flat+ \rightarrow D\flat+$. This arrival on B_5 initiates an acceleration of the descending chromatic line in the alto that begins on $E\flat_6$ on the fifth eighth-note of m. 8 and ends on $E\flat_5$ (as part of $C+^7$) on the downbeat of m. 9

mm. 12-14

A more complex passage occurs in mm. 12-14, given in Example 25, where chords that do not correspond to the harmonic structures of Example 3 are labeled according to standard jazz notation. We can readily observe some familiar motions from elsewhere in the Etude: cycles of ascending fifths, or double-Rotations, $G+ \rightarrow D+ \rightarrow A+$, several ascending minor-third progressions, and a chain of T_{10} -cycles in m. 14, $(E+ \rightarrow G+) \xrightarrow{T_{10}} (D+ \rightarrow F+)$. However, there are deeper connections with the simpler harmonic progressions we have already discussed that are obscured by these standard chord symbols. For example, the first chord of m. 13 can also be viewed as a poly-chord with $C\sharp_4$ in the right hand over $E\flat_7$ in the left. The close spacing in the right hand combined with the registral separation of the two hands encourages this hearing, as does the fact that the $F\sharp$ contained within a close-spaced C major triad is much easier to hear as s4 of C than $\sharp 9$ of $E\flat$. Compare the actual registral distribution of pitches in the music with the more evenly spaced arrangement in Example 26a, where the pitches are more likely to fuse into a single sonority. As Example 26b shows, reading $E\flat^{7(b_9 \sharp 13)}$ as the poly-chord $C\sharp_4/E\flat_7$ suggests that it arises through a compression of the minor-third cycle $A+ \rightarrow C+ \rightarrow E\flat+ \rightarrow G\flat+$. It is fairly natural to hear the upper layer (right hand) articulating the progression $A+ \rightarrow C+ \rightarrow G\flat+$ (beginning with the last eighth of m. 12); the $E\flat_7$ thus serves to “fill in the gap” between $C+$ and $G\flat+$.

Taking a more holistic view of this chord and its position within the larger progression, Example 27 gives a simplified version of m. 13, one in which all of the chords are combinations of stacked fifths at the major or minor third. While Example 27 certainly lacks the interest of the original, it is sufficiently similar to be considered a plausible underlying harmonic basis for the chromatic alterations. Example 28 shows how this basis fits within the scheme of *Slides* and *Rotations* acting on extended tertian harmonies. For each chord, the two stacks of fifths are offset to the left and right slightly for visual clarity. An upward shift

Example 25. *Ligeti, Are-en-ciel, mm. 12-14.*

- - *allarg.* - - - *accel.* - - -

(non arpegg.)
G+ D+ A+

13 - - - *a tempo, allarg., a tempo* *molto rubato* *allarg.* - - -

(*dim. poco a poco*) *p* *poco cresc.* - - -

E \flat 7 (6+9 #9 13) G \flat 7(M7) B \flat mi \sharp 11 B \flat 7 \sharp 11 E+ G7(M7) D+ F7 \sharp 11 A-/C+

Example 26. a) E \flat 7 (6+9 #9 13 n15) as a fused chord; b) the poly-chord C \sharp /E \flat 7 as a compression of a minor-third cycle.

a.

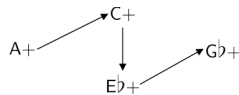

b.

Example 27. *Simplified version of m. 13.*

A+ E \flat + (15) G \flat + B \flat - B \flat + E+

of the lowest pitch by a third from one chord to the next corresponds to a *Rotation*, while a semitonal shift of one stack of fifths corresponds to a *Slide*. Pitches in the Example not present in the music are given in gray as are *Slides* into these omitted pitches. The tritone progression from $A+$ to $E\flat+$ can be viewed as a double-*Rotation* ($A+ \rightarrow E+$) combined with a semitonal slide of both stacks of fifths, a double-*Slide* or simply T_{-1} ($E+ \rightarrow E\flat+$). (Since SI and Rt are commutative, this can be rewritten as $(SIRt)^2$, which clearly shows the compression of two *Slide-Rotations* discussed in connection with Example 26b.) While Ligeti avoids motions such as $E+^7 \rightarrow E\flat^7$, where an entire seventh chord descends by semitone (see the discussion accompanying Example 9), the situation here, in which the first major seventh is embedded in the upper extensions of $A+$, is fundamentally different, since the root motion by tritone serves to disguise the uniform semitonal descent. An exactly analogous situation occurs in the motion from $B\flat+$ to $E+$ at the end of m. 13.

Example 28. *Slides and Rotations in Example 26.*

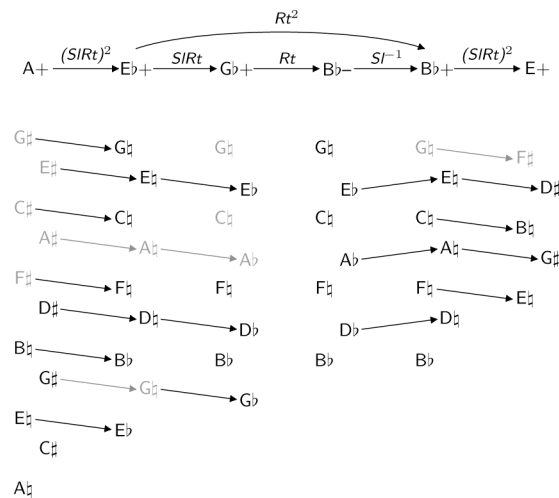

With the beginning of m. 13 the number of active extensions is increased to include the 15th and 17th, with the 15th ($E\flat$) in particular creating a high degree of harmonic tension. This tension is gradually relaxed by progressively raising the root by thirds through a couple of *Rotations* without also raising the upper tones, thereby producing a reduction in the number of extensions. In effect, the upper extensions over $E\flat$ become progressively lower extensions over $G\flat$ and $B\flat$. Accompanying these *Rotations* are a single *Slide*, providing access to $G\flat+$ and $B\flat-$, followed by a single inverse *Slide* to $B\flat+$ that neutralizes the effect of the previous *Slide*. Reducing out these contradicting *Slides*, we can understand the progression $E\flat+ \rightarrow G\flat+ \rightarrow B\flat- \rightarrow B\flat+$ as an elaboration of the double-*Rotation* from $E\flat+$ to $B\flat+$.

Example 29 plots the actual chord progression of mm. 12-13 in the same manner as the simplified version in Example 28. Comparison of Examples 29 and 28 suggests that the chord alterations in this passage may be viewed as arising from anticipations and delays of *Slides*. For example, the altered chord on E \flat results from D \sharp moving to D \flat “too early,” skipping the expected D \natural , while F \sharp moves to F \natural “too late,” suspending through the chord as $\sharp 9$. The E \natural in this altered chord, which can be understood as either the $\flat 9$ (or, less traditionally, $\natural 15$) on E \flat + or as part of the upper component in the C+/E \flat poly-chord, never resolves to the expected E \flat , instead suspending to become part of the Monk seventh on G \flat + and the $\sharp 11$ on both B \flat - and B \flat +. Finally, the A \flat in B \flat - does not ascend to the expected A \natural as part of B \flat +, but is held in common forming a part of the altered dominant chord on B \flat that sets up a return to the relaxed recollection of the opening on beat 3 of m. 13 with a simple major seventh chord. In the motion from B \flat mi 7 ($9 \sharp 11 13$) to B \flat 7 ($\sharp 9 \sharp 11$), one might be tempted to view D \flat and C as rising in parallel motion to D \natural and C \sharp . However, since C \sharp_5 is held over as a common tone from D \flat_5 in the previous chord, it seems more accurate to describe D \flat as moving obliquely into a true split-third, D \flat /D \natural . The remainder of the passage given in Example 24, from the 3rd beat of m. 13 on, is a fairly straightforward chain of T_{10} cycles with some elaboration. In particular, there are two “Monk sevenths” with F \sharp and F \natural both occurring over G at the beginning of m. 14 and E \natural and E \flat occurring over F in the middle of the same bar. In both cases, the minor seventh over the root functions as a chromatic passing tone into the following harmony.

Example 29. *Slides and Rotations in m. 13.*

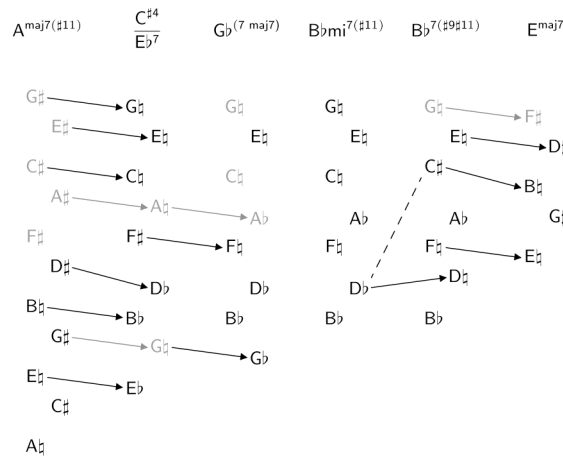

The goal in analyzing these two passages is not to shoehorn every moment of the 24-bar Etude into a given system of transformations on a particular type of extended tertian harmony, but to demonstrate connections between the more complex harmonic progressions and the simpler motions observed in the opening. In so doing, we have

touched on some of the logical and aesthetic constraints that seem likely to have been a part of the compositional process. The combination of the lamento motif with simple jazz harmonies naturally gives rise to a limited number of possible harmonic patterns, and a traditional desire to maintain some manner of consistency in the process of elaborating the opening materials likely led the composer to preserve these patterns through much of the Etude.

References

- Balzano, Gerald. 1980. The Group-Theoretic Description of 12-Fold and Microtonal Pitch Systems. *Computer Music Journal* 4: 66–84.
- Bernard, Jonathan. 1994. Voice Leading as a Spatial Function in the Music of Ligeti. *Music Analysis* 13: 227–253.
- Bouliane, Denys. 1989. Les Six études pour piano de György Ligeti ou l'art subtil de créer en assumant les référents culturelles. *Canadian university music review* 9: 36–83.
- Callender, Clifton and Nancy Rogers. 2006. Judgments of Distance between Trichords. In *Proceedings of the International Conference of Music Perception and Cognition*, M. Baroni, A. R. Addessi, R. Caterina, and M. Costa, 1686–1691.
- Clendinning, Jane. 1994. The Pattern-Meccanico Compositions of György Ligeti. *Perspectives of New Music* 31:192–234.
- Childs, Adrian. 1998. Moving beyond Neo-Riemannian Triads: Exploring a Transformational Model for Seventh Chords. *Journal of Music Theory* 42.2: 181-193.
- Cohn, Richard. 1991. Properties and Generability of Transpositionally Invariant Sets. *Journal of Music Theory* 35: 1–32.
- Cohn, Richard. 1996. Maximally Smooth Cycles, Hexatonic Systems, and the Analysis of Late-Romantic Triadic Progressions. *Music Analysis* 15: 9–40.
- Cohn, Richard. 1997. Neo-Riemannian Operations, Parsimonious Trichords, and their Tonnetz Representations. *Journal of Music Theory* 41: 1–66.
- Cohn, Richard. 1998. Square Dances with Cubes. *Journal of Music Theory* 42: 283–296.
- Cohn, Richard. 2000. Weitzmann's Regions, My Cycles, and Douthett's Dancing Cubes. *Music Theory Spectrum* 22: 89–103.

Hauptmann, Moritz. 1853. *Die Natur der Harmonik und der Metrik*. Leipzig: Breitkopf und Härtel.

Kinzler, Hartmuth. György Ligeti: Decision and Automatism in Désordre, 1^{er} Étude, Premier Livre. *Interface* 20: 89–124

Krumhansl, Carol. 1998. Perceived Triad Distance: Evidence Supporting the Psychological Reality of Neo-Riemannian Operations. *Journal of Music Theory* 42: 265-281.

Kurzdorfer, James. 1996. Outrageous Clusters: Dissonant Semitonal Cells in the Music of Thelonius Monk. *Annual Review of Jazz Studies* 8: 181–201.

Lerdahl, Fred. 2001. *Tonal Pitch Space*. Oxford: Oxford University Press.

Lewin, David. 1982. A Formal Theory of Generalized Tonal Functions. *Journal of Music Theory* 26: 23–60.

Lewin, David. 1987. *Generalized Musical Intervals and Transformations*. New Haven: Yale University Press.

Ligeti, György. 1993. Liner notes to *Études pour Piano (premier livre)* / “Vingt regards sur l’Enfant-Jésus”. Wergo WER 60134-50.

Ligeti, György. 1996. Liner notes to *Ligeti: Works for Piano: Études, Musica Ricercata*. Sony SK 62308.

Morrison, Charles. 1985. Stepwise Continuity as a Structural Determinant in György Ligeti’s Ten Pieces for Wind Quintet. *Perspectives of New Music* 24: 158–182.

Roig-Francolí. 1995. Harmonic and Formal Processes in Ligeti’s Net-Structure Compositions. *Music Theory Spectrum* 17: 242–267.

Strunk, Stephen 2003. Wayne Shorter’s *Yes and no*: An Analysis. *Tijdschrift voor muziektheorie* 8: 40–56.

Taylor, Stephen. 1994. The Lamento Motif: Metamorphosis in Ligeti’s Late Style. DMA diss., Cornell University.

Taylor, Stephen. 1997. Chopin, Pygmies, and Tempo Fugue: Ligeti’s *Automne à Varsovie*,” *Music Theory Online* 3.3 .

Taylor, Stephen. 2004. Passacaglia and Lament in Ligeti's Recent Music. *Tijdschrift voor muziektheorie* 9: 1–11.

Vial, Françoise Guillaume. 1767. *Arbre Généalogique de l'harmonie*. Paris.

Weber, Gottfried. 1821–1824. *Versuch einer geordneten Theorie der Tonsetzkunst*. Mainz: B. Schotts Söhne.

Weitzmann, Carl Friedrich. 1853. *Der übermässige Dreiklang*. Berlin: T. Trautweinschen.